

# PALMER INDUSTRIES

CUSTOM SINK LEG SOLUTIONS



*The Bristol*

**SINK**20  
24**LEGS**

March 15, 2024

American Manufacturing  
Warwick, Rhode Island



# PALMER INDUSTRIES

CUSTOM SINK LEG SOLUTIONS



Bayonne

Palmer Industries is the leading manufacturer of vanity sink legs. Palmer washstands are proudly manufactured in the USA – designed, fabricated, assembled, and packaged in our Rhode Island facility. We maintain complete control over the entire process, enabling Palmer to custom fabricate any style, any size, any configuration, and any finish, efficiently and accurately.

All page numbers shown in the Table of Contents or referenced on any page are active HyperLinks, click on them and they will take you to that page. Many other references are also active links.

## Table of Contents

click on a page number to navigate

The Palmer Story	4
Custom Sizing	6
Custom Designs	7
Precision Engineering	8

### STYLES

<i>Classic Collection</i>	
<b>T</b> Tapered Foot	12
<b>C</b> Decorative Collar	13
<b>BL</b> Ball Foot	14
<b>B</b> Bun Foot	15
<i>Traditional Collection</i>	
<b>E</b> Essex	16
<b>W</b> Westport	17
<b>CAP</b> Capital	18
<b>K</b> Kingston	19
<b>V</b> Victorian	20
<b>P</b> Providence	21
<b>REN</b> Renaissance	22
<b>PREN</b> Petite Renaissance	23
<b>N</b> Newport	24
<b>BAY</b> Bayonne	25
<b>FR</b> Franklin	25
<b>EM</b> Embry	26
<b>SH</b> Soho	27
<i>Modern Collection</i>	
<b>S</b> Studio	28
<b>M</b> Minimal	29
<b>MET</b> Metro	30
<b>MOD</b> Modern	31
<b>SQ</b> Square	32
<b>L</b> Linear	33
<b>J</b> Jamestown	34
<b>BR</b> Bristol	35
<i>Wall Mount Collection</i>	
<b>REG</b> Regency	36
<b>A</b> Apex	37
<b>SG</b> Signature	38

Finishes & Materials	40
Shelving & Supports	42
Options & Accessories	44
Pairing with China Sinks	47
Anatomy of a Leg System	48
Tubing Diameter Reference	49
Contact Palmer	50



As a designer, engineer, and manufacturer of custom architectural metalwork, Palmer specializes in the production of America's finest Custom Vanity Sink Legs.

Sink Legs do not simply play a supporting role in the design of your vanity; they play the defining role. The choice between elegant legs or just a wood box changes everything...

A Palmer leg system will integrate perfectly with your unique choices of personal colors, wall, floor, and counter materials, plumbing fixtures, and style.

Palmer washstands will support any choice of counter material, such as granite, marble, quartz, porcelain, cement, composite, glass, metal, or wood. You provide the counter, and Palmer will design the perfect leg system exactly to your unique specifications... an ideal marriage.

Engineered in solid brass and richly finished in a full palette of lustrous platings and hand-rubbed patinas, Palmer Industries brings you the finest in custom vanity sink legs, perfectly at home in your elegant master bedroom suite or your understated powder room.

click on a page number to navigate

The Palmer Story	4
Custom Sizing	6
Custom Designs	7
Precision Engineering	8

STYLES

<i>Classic Collection</i>	
<b>T</b> Tapered Foot	12
<b>C</b> Decorative Collar	13
<b>BL</b> Ball Foot	14
<b>B</b> Bun Foot	15
<i>Traditional Collection</i>	
<b>E</b> Essex	16
<b>W</b> Westport	17
<b>CAP</b> Capital	18
<b>K</b> Kingston	19
<b>V</b> Victorian	20
<b>P</b> Providence	21
<b>REN</b> Renaissance	22
<b>PREN</b> Petite Renaissance	23
<b>N</b> Newport	24
<b>BAY</b> Bayonne	25
<b>FR</b> Franklin	25
<b>EM</b> Embry	26
<b>SH</b> Soho	27
<i>Modern Collection</i>	
<b>S</b> Studio	28
<b>M</b> Minimal	29
<b>MET</b> Metro	30
<b>MOD</b> Modern	31
<b>SQ</b> Square	32
<b>L</b> Linear	33
<b>J</b> Jamestown	34
<b>BR</b> Bristol	35
<i>Wall Mount Collection</i>	
<b>REG</b> Regency	36
<b>A</b> Apex	37
<b>SG</b> Signature	38

Finishes & Materials	40
Shelving & Supports	42
Options & Accessories	44
Pairing with China Sinks	47
Anatomy of a Leg System	48
Tubing Diameter Reference	49
Contact Palmer	50





At Palmer, Custom Sizing is not "Custom"...

Each and every leg system is built to order...  
one at a time...  
to your exact size

One artisan...  
One leg system...  
One individual  
"work of art"



Tapered Foot

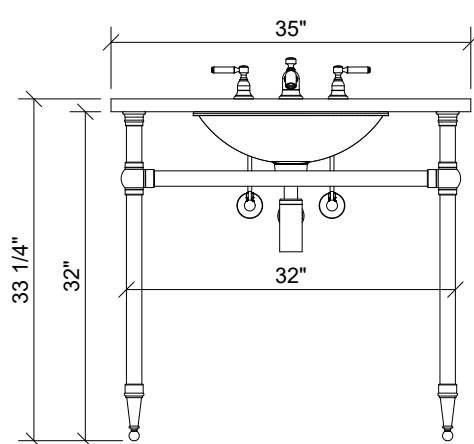
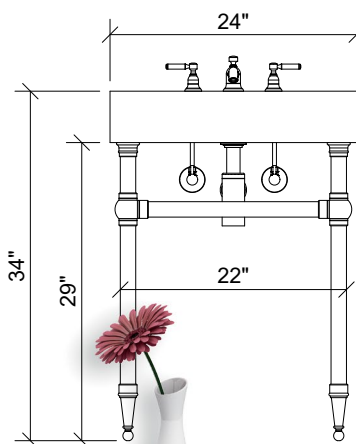
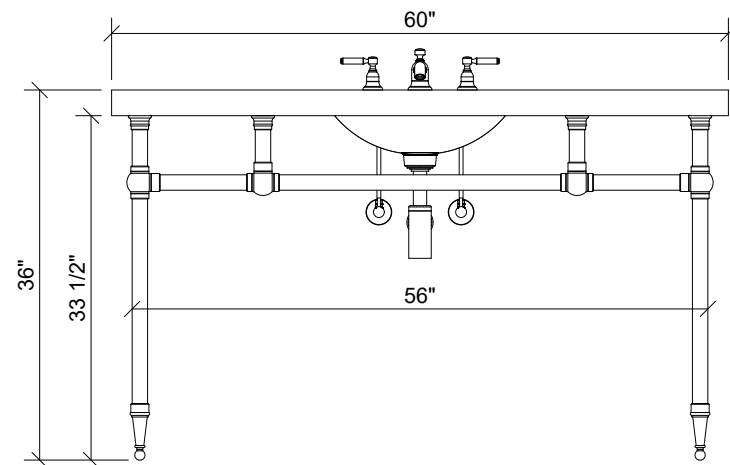

Because Palmer hand builds ALL leg systems to order, we can easily adjust the width, depth, and finished height to suit your customer's exact needs for a modest additional cost.

Give us your counter dimensions and we'll deliver an exact fit.



R-020723

R-020723

Palmer is a Boutique Designer & Manufacturer



If You Can Dream It,  
Palmer Can Build It...



Tapered Foot

From your inspiration to the final polishing touch, Palmer's dedicated team of engineers and artisans can take your project from conception to completion.

Provide us with your simple sketch, magazine clipping, or concept images from social media, and Palmer will quickly propose a solution to accommodate your design intent.

Table of Contents

click on a page number to navigate

The Palmer Story	4
Custom Sizing	6
Custom Designs	7
Precision Engineering	8

STYLES

<b>Classic Collection</b>	
<b>T</b> Tapered Foot	12
<b>C</b> Decorative Collar	13
<b>BL</b> Ball Foot	14
<b>B</b> Bun Foot	15
<b>Traditional Collection</b>	
<b>E</b> Essex	16
<b>W</b> Westport	17
<b>CAP</b> Capital	18
<b>K</b> Kingston	19
<b>V</b> Victorian	20
<b>P</b> Providence	21
<b>REN</b> Renaissance	22
<b>PREN</b> Petite Renaissance	23
<b>N</b> Newport	24
<b>BAY</b> Bayonne	25
<b>FR</b> Franklin	25
<b>EM</b> Embry	26
<b>SH</b> Soho	27
<b>Modern Collection</b>	
<b>S</b> Studio	28
<b>M</b> Minimal	29
<b>MET</b> Metro	30
<b>MOD</b> Modern	31
<b>SQ</b> Square	32
<b>L</b> Linear	33
<b>J</b> Jamestown	34
<b>BR</b> Bristol	35
<b>Wall Mount Collection</b>	
<b>REG</b> Regency	36
<b>A</b> Apex	37
<b>SG</b> Signature	38

Finishes & Materials	40
Shelving & Supports	42
Options & Accessories	44
Pairing with China Sinks	47
Anatomy of a Leg System	48
Tubing Diameter Reference	49
Contact Palmer	50

any style, any size, any configuration, and any finish...



Palmer specializes in meeting your custom design needs:

## Flexible Design... Rigid Assembly...

Palmer offers unlimited design flexibility to create exactly the style and configuration of console you prefer, while never compromising the engineering details that ultimately produce a sound and rigid assembly.

Our internal "unseen" components are just as impressive in their function as our external decorative fittings are in their form.

Components such as custom-designed reinforcing plugs and nuts, tubing connectors, and heavy-duty machine fasteners (never "sheet-metal" screws), all chosen in appropriate metals such as stainless steel and tempered aluminum, are carefully integrated to produce a seamless and lasting console.



## Table of Contents

click on a page number to navigate

The Palmer Story	4
Custom Sizing	6
Custom Designs	7
Precision Engineering	8

### STYLES

**Classic Collection**

<b>T</b> Tapered Foot	12
<b>C</b> Decorative Collar	13
<b>BL</b> Ball Foot	14
<b>B</b> Bun Foot	15

**Traditional Collection**

<b>E</b> Essex	16
<b>W</b> Westport	17
<b>CAP</b> Capital	18
<b>K</b> Kingston	19
<b>V</b> Victorian	20
<b>P</b> Providence	21
<b>REN</b> Renaissance	22
<b>PREN</b> Petite Renaissance	23
<b>N</b> Newport	24
<b>BAY</b> Bayonne	25
<b>FR</b> Franklin	25
<b>EM</b> Embry	26
<b>SH</b> Soho	27

**Modern Collection**

<b>S</b> Studio	28
<b>M</b> Minimal	29
<b>MET</b> Metro	30
<b>MOD</b> Modern	31
<b>SQ</b> Square	32
<b>L</b> Linear	33
<b>J</b> Jamestown	34
<b>BR</b> Bristol	35

**Wall Mount Collection**

<b>REG</b> Regency	36
<b>A</b> Apex	37
<b>SG</b> Signature	38

Finishes & Materials	40
Shelving & Supports	42
Options & Accessories	44
Pairing with China Sinks	47
Anatomy of a Leg System	48
Tubing Diameter Reference	49
Contact Palmer	50

# STYLES

a gallery of images



Westport



index to a gallery of images

## Classic Collection

- T** Tapered Foot 12
- C** Decorative Collar 13
- BL** Ball Foot 14
- B** Bun Foot 15

## Traditional Collection

- E** Essex 16
- W** Westport 17
- CAP** Capital 18
- K** Kingston 19
- V** Victorian 20
- P** Providence 21
- REN** Renaissance 22
- PREN** Petite Ren 23
- N** Newport 24
- BAY** Bayonne 25
- FR** Franklin 25
- EM** Embry 26
- SH** Soho 27

## Modern Collection

- S** Studio 28
- M** Minimal 29
- MET** Metro 30
- MOD** Modern 31
- SQ** Square 32
- L** Linear 33
- J** Jamestown 34
- BR** Bristol 35

## Wall Mount Collection

- REG** Regency 36
- A** Apex 37
- SG** Signature 38

R-011524

R-011524



# Table of Contents

click on a page number to navigate

The Palmer Story	4
Custom Sizing	6
Custom Designs	7
Precision Engineering	8

## STYLES

<b>Classic Collection</b>	
<b>T</b> Tapered Foot	12
<b>C</b> Decorative Collar	13
<b>BL</b> Ball Foot	14
<b>B</b> Bun Foot	15
<b>Traditional Collection</b>	
<b>E</b> Essex	16
<b>W</b> Westport	17
<b>CAP</b> Capital	18
<b>K</b> Kingston	19
<b>V</b> Victorian	20
<b>P</b> Providence	21
<b>REN</b> Renaissance	22
<b>PREN</b> Petite Renaissance	23
<b>N</b> Newport	24
<b>BAY</b> Bayonne	25
<b>FR</b> Franklin	25
<b>EM</b> Embry	26
<b>SH</b> Soho	27
<b>Modern Collection</b>	
<b>S</b> Studio	28
<b>M</b> Minimal	29
<b>MET</b> Metro	30
<b>MOD</b> Modern	31
<b>SQ</b> Square	32
<b>L</b> Linear	33
<b>J</b> Jamestown	34
<b>BR</b> Bristol	35
<b>Wall Mount Collection</b>	
<b>REG</b> Regency	36
<b>A</b> Apex	37
<b>SG</b> Signature	38
<b>Finishes &amp; Materials</b>	
Shelving & Supports	42
Options & Accessories	44
Pairing with China Sinks	47
Anatomy of a Leg System	48
Tubing Diameter Reference	49
Contact Palmer	50



# TAPERED FOOT

T

The *Tapered Foot* console, with its classic foot detail and distinctive ball corner joints, remains Palmer's most popular style.



LS21T with MTI Modern counter

available in 1½" diameter and 1" diameter tubing

LS2T

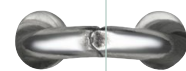

R-020723

R-020723

# DECORATIVE COLLAR

C

The crisply machined decorative collars, positioned below the corner joints and used as feet, define the *Decorative Collar* style.



LS5C + TS5 + SS5R + TRL + TRR

shown above with optional hotel style shelf, rail shelf supports, and auxiliary towel rails

available in 1½" diameter and 1" diameter tubing



LS2C

click on a page number to navigate

The Palmer Story	4
Custom Sizing	6
Custom Designs	7
Precision Engineering	8

### STYLES

<b>Classic Collection</b>	
T Tapered Foot	12
C Decorative Collar	13
BL Ball Foot	14
B Bun Foot	15
<b>Traditional Collection</b>	
E Essex	16
W Westport	17
CAP Capital	18
K Kingston	19
V Victorian	20
P Providence	21
REN Renaissance	22
PREN Petite Renaissance	23
N Newport	24
BAY Bayonne	25
FR Franklin	25
EM Embry	26
SH Soho	27
<b>Modern Collection</b>	
S Studio	28
M Minimal	29
MET Metro	30
MOD Modern	31
SQ Square	32
L Linear	33
J Jamestown	34
BR Bristol	35
<b>Wall Mount Collection</b>	
REG Regency	36
A Apex	37
SG Signature	38

Finishes & Materials	40
Shelving & Supports	42
Options & Accessories	44
Pairing with China Sinks	47
Anatomy of a Leg System	48
Tubing Diameter Reference	49
Contact Palmer	50



# BALL FOOT

BL

The *Ball Foot* style features Palmer's unique ball-and-socket corner joints, with their sharp lines and visual heft, paired with perfectly matching ball feet.



LS2BL + SD

shown with split diameter option

available in 1½" diameter and 1" diameter tubing

LS2BL + SD

# BUN FOOT

B

The bun foot has long been a classic architectural feature in fine furniture design, and Palmer's *Bun Foot* console features a robust and elegant version of this style.



LS2B + FR

shown above with Palmer custom mirror supports and optional front riser

available in 1½" diameter and 1" diameter tubing

LS2B



R-020723

R-020723



click on a page number to navigate

The Palmer Story	4
Custom Sizing	6
Custom Designs	7
Precision Engineering	8

### STYLES

<b>Classic Collection</b>	
<b>T</b> Tapered Foot	12
<b>C</b> Decorative Collar	13
<b>BL</b> Ball Foot	14
<b>B</b> Bun Foot	15

<b>Traditional Collection</b>	
<b>E</b> Essex	16
<b>W</b> Westport	17
<b>CAP</b> Capital	18
<b>K</b> Kingston	19
<b>V</b> Victorian	20
<b>P</b> Providence	21
<b>REN</b> Renaissance	22
<b>PREN</b> Petite Renaissance	23
<b>N</b> Newport	24
<b>BAY</b> Bayonne	25
<b>FR</b> Franklin	25
<b>EM</b> Embry	26
<b>SH</b> Soho	27

<b>Modern Collection</b>	
<b>S</b> Studio	28
<b>M</b> Minimal	29
<b>MET</b> Metro	30
<b>MOD</b> Modern	31
<b>SQ</b> Square	32
<b>L</b> Linear	33
<b>J</b> Jamestown	34
<b>BR</b> Bristol	35

<b>Wall Mount Collection</b>	
<b>REG</b> Regency	36
<b>A</b> Apex	37
<b>SG</b> Signature	38

Finishes & Materials	40
Shelving & Supports	42
Options & Accessories	44
Pairing with China Sinks	47
Anatomy of a Leg System	48
Tubing Diameter Reference	49
Contact Palmer	50





click on a page number to navigate

# ESSEX

E

The *Essex* features a refined tapered leg paired with a slender foot and perfectly coordinated fittings.



LS2E

1½" diameter legs tapering to 1" diameter at the foot

1" diameter crossbars

LS2E



R-020723

R-020723

# WESTPORT

W

The *Westport* features a round head transitioning to a slender leg, with complementary fittings, and a single horizontal crossbar.



LS2W

1½" diameter head  
1" diameter legs  
1" diameter crossbars

LS2W

## STYLES

### Classic Collection

T Tapered Foot	12
C Decorative Collar	13
BL Ball Foot	14
B Bun Foot	15

### Traditional Collection

E Essex	16
W Westport	17
CAP Capital	18
K Kingston	19
V Victorian	20
P Providence	21
REN Renaissance	22
PREN Petite Renaissance	23
N Newport	24
BAY Bayonne	25
FR Franklin	25
EM Embry	26
SH Soho	27

### Modern Collection

S Studio	28
M Minimal	29
MET Metro	30
MOD Modern	31
SQ Square	32
L Linear	33
J Jamestown	34
BR Bristol	35

### Wall Mount Collection

REG Regency	36
A Apex	37
SG Signature	38

Finishes & Materials	40
Shelving & Supports	42
Options & Accessories	44
Pairing with China Sinks	47
Anatomy of a Leg System	48
Tubing Diameter Reference	49
Contact Palmer	50



# CAPITAL

CAP

The *Capital* style is defined by its prominent square head, slender leg, and distinctive double horizontal crossbars.



LS2CAP

shown above with Palmer custom wall-mounted Towel Rack

1½" square head  
1" diameter legs  
1" diameter crossbars

LS2CAP

# KINGSTON

K

Vintage tapered legs with decorative collars, classic ball-and-socket joints, a tapered foot, and slender crossbars all combine to create the *Kingston*.



LS2K

1½" diameter legs tapering to 1" diameter at the foot

1" diameter crossbars

LS2K

click on a page number to navigate

The Palmer Story	4
Custom Sizing	6
Custom Designs	7
Precision Engineering	8

### STYLES

<b>Classic Collection</b>	
<b>T</b> Tapered Foot	12
<b>C</b> Decorative Collar	13
<b>BL</b> Ball Foot	14
<b>B</b> Bun Foot	15
<b>Traditional Collection</b>	
<b>E</b> Essex	16
<b>W</b> Westport	17
<b>CAP</b> Capital	18
<b>K</b> Kingston	19
<b>V</b> Victorian	20
<b>P</b> Providence	21
<b>REN</b> Renaissance	22
<b>PREN</b> Petite Renaissance	23
<b>N</b> Newport	24
<b>BAY</b> Bayonne	25
<b>FR</b> Franklin	25
<b>EM</b> Embry	26
<b>SH</b> Soho	27
<b>Modern Collection</b>	
<b>S</b> Studio	28
<b>M</b> Minimal	29
<b>MET</b> Metro	30
<b>MOD</b> Modern	31
<b>SQ</b> Square	32
<b>L</b> Linear	33
<b>J</b> Jamestown	34
<b>BR</b> Bristol	35
<b>Wall Mount Collection</b>	
<b>REG</b> Regency	36
<b>A</b> Apex	37
<b>SG</b> Signature	38

Finishes & Materials	40
Shelving & Supports	42
Options & Accessories	44
Pairing with China Sinks	47
Anatomy of a Leg System	48
Tubing Diameter Reference	49
Contact Palmer	50



R-020723

R-020723



# VICTORIAN

V

The *Victorian* offers an artfully crafted and open design, featuring auxiliary towel rails and split collar shelf supports, while incorporating ample storage space below.



LS41V

1" diameter legs  
5/8" diameter towel rails

shown with stone shelf  
supplied by customer

LS41V

# PROVIDENCE

P

The *Providence* model, featuring a striking square head, turned neck, and mildly tapered legs, seamlessly incorporates stone aprons (a "skirt") concealing the sink basin and hardware below the counter.



LS2P

2" square head

1 1/2" diameter legs tapering to  
1" diameter at the foot

stone top & aprons by others



R-020723

R-020723



click on a page number to navigate

The Palmer Story	4
Custom Sizing	6
Custom Designs	7
Precision Engineering	8

### STYLES

<b>Classic Collection</b>	
<b>T</b> Tapered Foot	12
<b>C</b> Decorative Collar	13
<b>BL</b> Ball Foot	14
<b>B</b> Bun Foot	15
<b>Traditional Collection</b>	
<b>E</b> Essex	16
<b>W</b> Westport	17
<b>CAP</b> Capital	18
<b>K</b> Kingston	19
<b>V</b> Victorian	20
<b>P</b> Providence	21
<b>REN</b> Renaissance	22
<b>PREN</b> Petite Renaissance	23
<b>N</b> Newport	24
<b>BAY</b> Bayonne	25
<b>FR</b> Franklin	25
<b>EM</b> Embry	26
<b>SH</b> Soho	27
<b>Modern Collection</b>	
<b>S</b> Studio	28
<b>M</b> Minimal	29
<b>MET</b> Metro	30
<b>MOD</b> Modern	31
<b>SQ</b> Square	32
<b>L</b> Linear	33
<b>J</b> Jamestown	34
<b>BR</b> Bristol	35
<b>Wall Mount Collection</b>	
<b>REG</b> Regency	36
<b>A</b> Apex	37
<b>SG</b> Signature	38

Finishes & Materials	40
Shelving & Supports	42
Options & Accessories	44
Pairing with China Sinks	47
Anatomy of a Leg System	48
Tubing Diameter Reference	49
Contact Palmer	50



# RENAISSANCE

REN

The *Renaissance* console, with its broadly sweeping center curve flanked by pairs of legs on either side, represents a classic and timeless architectural style.



LS41REN

shown above with a Stone Forest Renaissance sink and featuring a matching Palmer wall-mounted Towel Rack and free-standing Palmer Étagère

1" diameter legs  
1" diameter crossbars

LS41REN

# PETITE RENAISSANCE

PREN

The *Petite Renaissance* model, is a narrower, 2 leg, diminutive version of our popular 4 leg Renaissance washstand.



LS21REN

shown above with a Stone Forest Petite-Renaissance sink C92-WL30

1" diameter legs  
1" diameter crossbars

LS21REN

click on a page number to navigate

The Palmer Story	4
Custom Sizing	6
Custom Designs	7
Precision Engineering	8

## STYLES

<b>Classic Collection</b>	
T Tapered Foot	12
C Decorative Collar	13
BL Ball Foot	14
B Bun Foot	15
<b>Traditional Collection</b>	
E Essex	16
W Westport	17
CAP Capital	18
K Kingston	19
V Victorian	20
P Providence	21
REN Renaissance	22
PREN Petite Renaissance	23
N Newport	24
BAY Bayonne	25
FR Franklin	25
EM Embry	26
SH Soho	27
<b>Modern Collection</b>	
S Studio	28
M Minimal	29
MET Metro	30
MOD Modern	31
SQ Square	32
L Linear	33
J Jamestown	34
BR Bristol	35

<b>Wall Mount Collection</b>	
REG Regency	36
A Apex	37
SG Signature	38

Finishes & Materials	40
Shelving & Supports	42
Options & Accessories	44
Pairing with China Sinks	47
Anatomy of a Leg System	48
Tubing Diameter Reference	49
Contact Palmer	50



# NEWPORT

N

A vanity console featuring the combination of classic metal finishes with the rich natural beauty of tapered walnut heartwood legs and horizontal crossbar.



LS2N + HB



LS2N + HB

Our rich walnut heartwood is a natural product; the color tone and wood grain will vary as each piece is unique

shown with optional hammered ball fittings

1 1/2" diameter legs tapering to 1" diameter at the foot

1" diameter crossbars

combination wood & metal front crossbar



R-020723

R-020723



# BAYONNE

BAY

The *Bayonne* console features four walnut legs and curved side-bars that complement the unique shape of the Stone Forest Bayonne top.

1 1/2" diameter legs tapering to 1" diameter at the foot

1" diameter crossbars

shown with optional hammered ball fittings



LS4BAY + HB

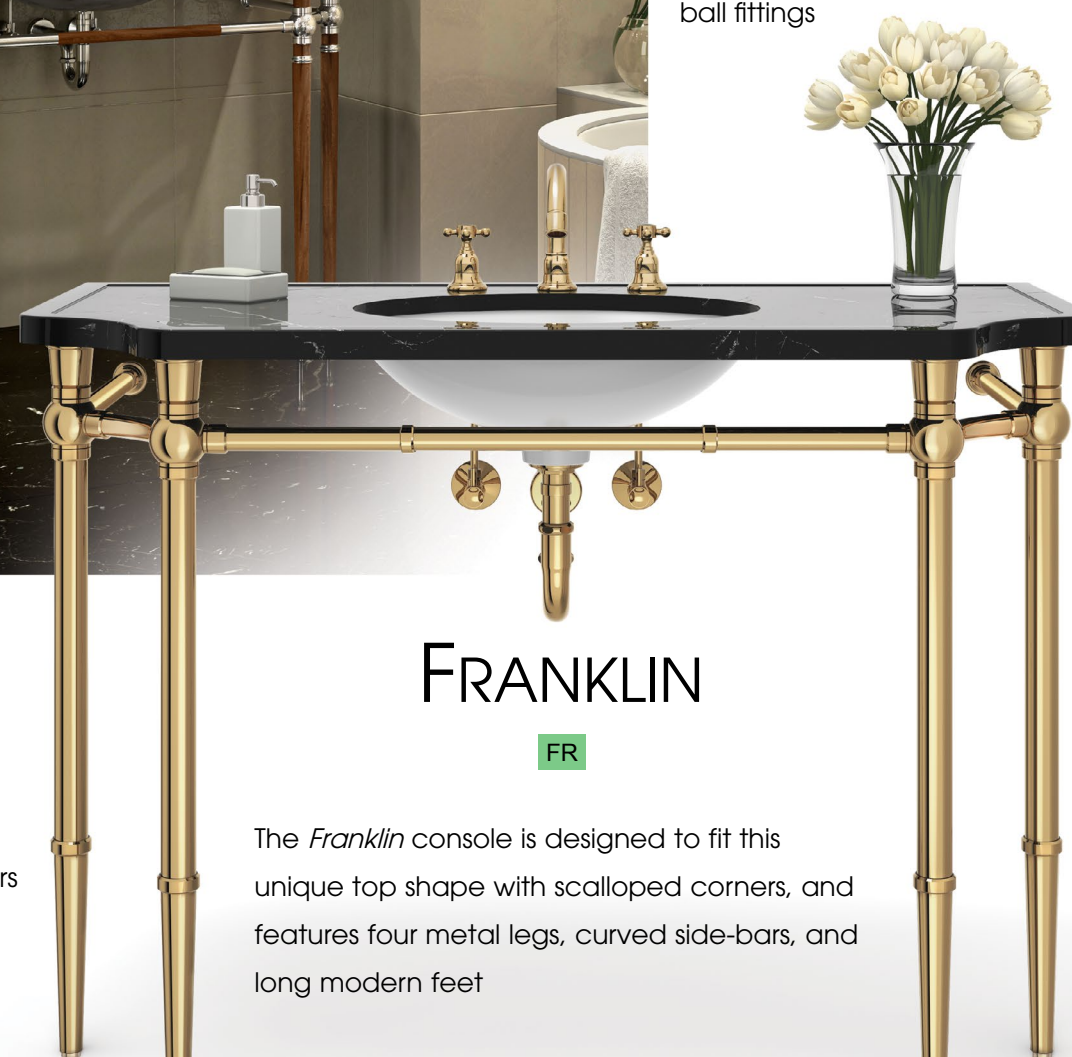

LS4FR

# FRANKLIN

FR

The *Franklin* console is designed to fit this unique top shape with scalloped corners, and features four metal legs, curved side-bars, and long modern feet

1 1/2" diameter legs  
1" diameter crossbars

click on a page number to navigate

The Palmer Story	4
Custom Sizing	6
Custom Designs	7
Precision Engineering	8

## STYLES

<b>Classic Collection</b>	
T Tapered Foot	12
C Decorative Collar	13
BL Ball Foot	14
B Bun Foot	15
<b>Traditional Collection</b>	
E Essex	16
W Westport	17
CAP Capital	18
K Kingston	19
V Victorian	20
P Providence	21
REN Renaissance	22
PREN Petite Renaissance	23
N Newport	24
BAY Bayonne	25
FR Franklin	25
EM Embry	26
SH Soho	27
<b>Modern Collection</b>	
S Studio	28
M Minimal	29
MET Metro	30
MOD Modern	31
SQ Square	32
L Linear	33
J Jamestown	34
BR Bristol	35
<b>Wall Mount Collection</b>	
REG Regency	36
A Apex	37
SG Signature	38

Finishes & Materials	40
Shelving & Supports	42
Options & Accessories	44
Pairing with China Sinks	47
Anatomy of a Leg System	48
Tubing Diameter Reference	49
Contact Palmer	50



# EMBRY

EM

The Embry makes an elegant statement with its sturdy 2" diameter head transitioning through a sculpted neck into the leg's gentle taper. The distinct contrast in diameter defines this sophisticated silhouette.



The Embry leg incorporates a unique leveling pin in the bottom of the foot, allowing for 3/4" of height adjustment, correcting any out-of-level floor condition.

2" diameter head with tapered legs

EM200



R-011224

R-011224

# SOHO

SH

In an inspired, but radical, departure from our modular, tube & connector style vanity leg systems, Palmer introduces the curvaceous "Soho" precision-machined solid brass leg.



This elegant 33" tall leg flows from its widest embellishment at 2-3/4" diameter undulating gracefully down to a 5/8" ankle above

SH200

## STYLES

### Classic Collection

- T** Tapered Foot 12
- C** Decorative Collar 13
- BL** Ball Foot 14
- B** Bun Foot 15

### Traditional Collection

- E** Essex 16
- W** Westport 17
- CAP** Capital 18
- K** Kingston 19
- V** Victorian 20
- P** Providence 21
- REN** Renaissance 22
- PREN** Petite Renaissance 23
- N** Newport 24
- BAY** Bayonne 25
- FR** Franklin 25
- EM** Embry 26
- SH** Soho 27

### Modern Collection

- S** Studio 28
- M** Minimal 29
- MET** Metro 30
- MOD** Modern 31
- SQ** Square 32
- L** Linear 33
- J** Jamestown 34
- BR** Bristol 35

### Wall Mount Collection

- REG** Regency 36
- A** Apex 37
- SG** Signature 38

- Finishes & Materials 40
- Shelving & Supports 42
- Options & Accessories 44
- Pairing with China Sinks 47
- Anatomy of a Leg System 48
- Tubing Diameter Reference 49
- Contact Palmer 50



click on a page number to navigate

# STUDIO

S

The *Studio* console elevates modern industrial utility to a state of luxurious design with its sharp refined lines, and understated fittings.



LS2SNR with Catalano Zero 100 sink

available in 1½" diameter and 1" diameter tubing

LS2SNR



R-020723

R-020723



LS2M with Duravit DuraStyle sink

1½" diameter legs tapering to 1" diameter at the foot

1" diameter crossbars

# MINIMAL

M

The *Minimal* model, with its unadorned tapered legs and clean fittings, affords a sleek and fashionable sense for today's modern bathrooms.



LS2M

## STYLES

### Classic Collection

- T** Tapered Foot 12
- C** Decorative Collar 13
- BL** Ball Foot 14
- B** Bun Foot 15

### Traditional Collection

- E** Essex 16
- W** Westport 17
- CAP** Capital 18
- K** Kingston 19
- V** Victorian 20
- P** Providence 21
- REN** Renaissance 22
- PREN** Petite Renaissance 23
- N** Newport 24
- BAY** Bayonne 25
- FR** Franklin 25
- EM** Embry 26
- SH** Soho 27

### Modern Collection

- S** Studio 28
- M** Minimal 29
- MET** Metro 30
- MOD** Modern 31
- SQ** Square 32
- L** Linear 33
- J** Jamestown 34
- BR** Bristol 35

### Wall Mount Collection

- REG** Regency 36
- A** Apex 37
- SG** Signature 38

- Finishes & Materials 40
- Shelving & Supports 42
- Options & Accessories 44
- Pairing with China Sinks 47
- Anatomy of a Leg System 48
- Tubing Diameter Reference 49
- Contact Palmer 50



click on a page number to navigate

# METRO

MET

The *Metro* console offers clean uninterrupted lines and simple styling, in a diminutive scale well suited to smaller spaces.



LS21MET + TS2 + SS2LP

LS21MET + TS2 + SS2LP with Duravit Vero sink

shown with optional hotel style shelf and low profile shelf supports

available in 1" diameter legs with 5/8" diameter offset crossbars (as shown), and also 1 1/2" diameter legs with 1" diameter offset crossbars



R-020723



LS2MOD

1 1/2" diameter legs  
1" diameter crossbars

# MODERN

MOD

Inspired by Danish Modern design, the *Modern* console features a long sleek foot, smooth contours, and simple geometric patterns.



LS2MOD

## STYLES

### Classic Collection

- T** Tapered Foot 12
- C** Decorative Collar 13
- BL** Ball Foot 14
- B** Bun Foot 15

### Traditional Collection

- E** Essex 16
- W** Westport 17
- CAP** Capital 18
- K** Kingston 19
- V** Victorian 20
- P** Providence 21
- REN** Renaissance 22
- PREN** Petite Renaissance 23
- N** Newport 24
- BAY** Bayonne 25
- FR** Franklin 25
- EM** Embry 26
- SH** Soho 27

### Modern Collection

- S** Studio 28
- M** Minimal 29
- MET** Metro 30
- MOD** Modern 31
- SQ** Square 32
- L** Linear 33
- J** Jamestown 34
- BR** Bristol 35

### Wall Mount Collection

- REG** Regency 36
- A** Apex 37
- SG** Signature 38

- Finishes & Materials 40
- Shelving & Supports 42
- Options & Accessories 44
- Pairing with China Sinks 47
- Anatomy of a Leg System 48
- Tubing Diameter Reference 49
- Contact Palmer 50





click on a page number to navigate

# SQUARE

SQ

The contemporary *Square* model is defined by its strong horizontal and vertical lines created by the crisp-edge square tubing, and punctuated by complementary square and stylish fittings.



LS2SQ with Duravit Vero sink

1 1/2" square legs  
1" square crossbars

LS2SQ



R-020723  
R-020723



LS41L + GS4

1" square legs  
1" square crossbars

shown with custom fabricated marble top and optional glass shelf

# LINEAR

L

The integration of the strong rectilinear lines of square tubing with concealed flush joinery creates the cutting edge look and appeal of the *Linear* console.



LS41L + GS4

## STYLES

### Classic Collection

- T** Tapered Foot 12
- C** Decorative Collar 13
- BL** Ball Foot 14
- B** Bun Foot 15

### Traditional Collection

- E** Essex 16
- W** Westport 17
- CAP** Capital 18
- K** Kingston 19
- V** Victorian 20
- P** Providence 21
- REN** Renaissance 22
- PREN** Petite Renaissance 23
- N** Newport 24
- BAY** Bayonne 25
- FR** Franklin 25
- EM** Embry 26
- SH** Soho 27

### Modern Collection

- S** Studio 28
- M** Minimal 29
- MET** Metro 30
- MOD** Modern 31
- SQ** Square 32
- L** Linear 33
- J** Jamestown 34
- BR** Bristol 35

### Wall Mount Collection

- REG** Regency 36
- A** Apex 37
- SG** Signature 38

- Finishes & Materials 40
- Shelving & Supports 42
- Options & Accessories 44
- Pairing with China Sinks 47
- Anatomy of a Leg System 48
- Tubing Diameter Reference 49
- Contact Palmer 50



# JAMESTOWN

J

The smooth refined lines of the Danish Modern foot and a gracefully curved crossbar define the *Jamestown* style, and achieve a tasteful blending of traditional form with modern appeal.



LS2J + WS2 + SS2LP

1 1/2" diameter legs  
1" diameter crossbars

shown at left with Stone Forest Harbor sink, optional Teak wood shelf, & low profile shelf supports



LS2J + GS2 + SS2C-G

# BRISTOL

BR

Featuring precisely tapered legs, rectangular metal aprons, and hexagonal details, the *Bristol* style expresses a clean blend of modern design and industrial chic.



LS2BR

shown at right with optional glass shelf, & clip shelf supports

1 1/2" diameter legs tapering to 1" diameter at the foot



LS2BR + GS2 + SS2C-G



R-020723

R-020723

click on a page number to navigate

The Palmer Story	4
Custom Sizing	6
Custom Designs	7
Precision Engineering	8

## STYLES

<b>Classic Collection</b>	
<b>T</b> Tapered Foot	12
<b>C</b> Decorative Collar	13
<b>BL</b> Ball Foot	14
<b>B</b> Bun Foot	15
<b>Traditional Collection</b>	
<b>E</b> Essex	16
<b>W</b> Westport	17
<b>CAP</b> Capital	18
<b>K</b> Kingston	19
<b>V</b> Victorian	20
<b>P</b> Providence	21
<b>REN</b> Renaissance	22
<b>PREN</b> Petite Renaissance	23
<b>N</b> Newport	24
<b>BAY</b> Bayonne	25
<b>FR</b> Franklin	25
<b>EM</b> Embry	26
<b>SH</b> Soho	27
<b>Modern Collection</b>	
<b>S</b> Studio	28
<b>M</b> Minimal	29
<b>MET</b> Metro	30
<b>MOD</b> Modern	31
<b>SQ</b> Square	32
<b>L</b> Linear	33
<b>J</b> Jamestown	34
<b>BR</b> Bristol	35
<b>Wall Mount Collection</b>	
<b>REG</b> Regency	36
<b>A</b> Apex	37
<b>SG</b> Signature	38

Finishes & Materials	40
Shelving & Supports	42
Options & Accessories	44
Pairing with China Sinks	47
Anatomy of a Leg System	48
Tubing Diameter Reference	49
Contact Palmer	50



# REGENCY

REG

The *Regency* model, with its soft curves and masculine flair, offers a wall-hung vanity option for applications when a leg system is not practical, or a raised architectural concept is preferred.



WMREG



WMREG

1" diameter crossbar

shown with Stone Forest Petite Renaissance sink



R-020723

R-020723



# APEX

A

Featuring minimal exposed metalwork and a structurally sound geometric form, the *Apex* offers a space-saving and simple wall-hung approach to vanity installations.

The *Apex* style is available with decorative collars as shown at right, or without collars as shown below.



WMAC

shown with Stone Forest Vintage 27 sink



WMA

1" diameter tubing

shown with Stone Forest Vintage 27 sink

click on a page number to navigate

The Palmer Story	4
Custom Sizing	6
Custom Designs	7
Precision Engineering	8

### STYLES

<b>Classic Collection</b>	
<b>T</b> Tapered Foot	12
<b>C</b> Decorative Collar	13
<b>BL</b> Ball Foot	14
<b>B</b> Bun Foot	15
<b>Traditional Collection</b>	
<b>E</b> Essex	16
<b>W</b> Westport	17
<b>CAP</b> Capital	18
<b>K</b> Kingston	19
<b>V</b> Victorian	20
<b>P</b> Providence	21
<b>REN</b> Renaissance	22
<b>PREN</b> Petite Renaissance	23
<b>N</b> Newport	24
<b>BAY</b> Bayonne	25
<b>FR</b> Franklin	25
<b>EM</b> Embry	26
<b>SH</b> Soho	27
<b>Modern Collection</b>	
<b>S</b> Studio	28
<b>M</b> Minimal	29
<b>MET</b> Metro	30
<b>MOD</b> Modern	31
<b>SQ</b> Square	32
<b>L</b> Linear	33
<b>J</b> Jamestown	34
<b>BR</b> Bristol	35
<b>Wall Mount Collection</b>	
<b>REG</b> Regency	36
<b>A</b> Apex	37
<b>SG</b> Signature	38

Finishes & Materials	40
Shelving & Supports	42
Options & Accessories	44
Pairing with China Sinks	47
Anatomy of a Leg System	48
Tubing Diameter Reference	49
Contact Palmer	50



# SIGNATURE

SG

The *Signature* Wall Mount offers a simple yet refined solution to supporting wall-hung vanities, featuring Palmer's machined ball-and-socket details.



WMSG with Duravit Vero sink

1" diameter tubing



R-020723

R-020723



Studio

## PALMER

WE DO ALL THE LEG WORK FOR YOU

## Table of Contents

click on a page number to navigate

The Palmer Story	4
Custom Sizing	6
Custom Designs	7
Precision Engineering	8

### STYLES

<b>Classic Collection</b>	
<b>T</b> Tapered Foot	12
<b>C</b> Decorative Collar	13
<b>BL</b> Ball Foot	14
<b>B</b> Bun Foot	15
<b>Traditional Collection</b>	
<b>E</b> Essex	16
<b>W</b> Westport	17
<b>CAP</b> Capital	18
<b>K</b> Kingston	19
<b>V</b> Victorian	20
<b>P</b> Providence	21
<b>REN</b> Renaissance	22
<b>PREN</b> Petite Renaissance	23
<b>N</b> Newport	24
<b>BAY</b> Bayonne	25
<b>FR</b> Franklin	25
<b>EM</b> Embry	26
<b>SH</b> Soho	27
<b>Modern Collection</b>	
<b>S</b> Studio	28
<b>M</b> Minimal	29
<b>MET</b> Metro	30
<b>MOD</b> Modern	31
<b>SQ</b> Square	32
<b>L</b> Linear	33
<b>J</b> Jamestown	34
<b>BR</b> Bristol	35
<b>Wall Mount Collection</b>	
<b>REG</b> Regency	36
<b>A</b> Apex	37
<b>SG</b> Signature	38

Finishes & Materials	40
Shelving & Supports	42
Options & Accessories	44
Pairing with China Sinks	47
Anatomy of a Leg System	48
Tubing Diameter Reference	49
Contact Palmer	50



click on a page number to navigate

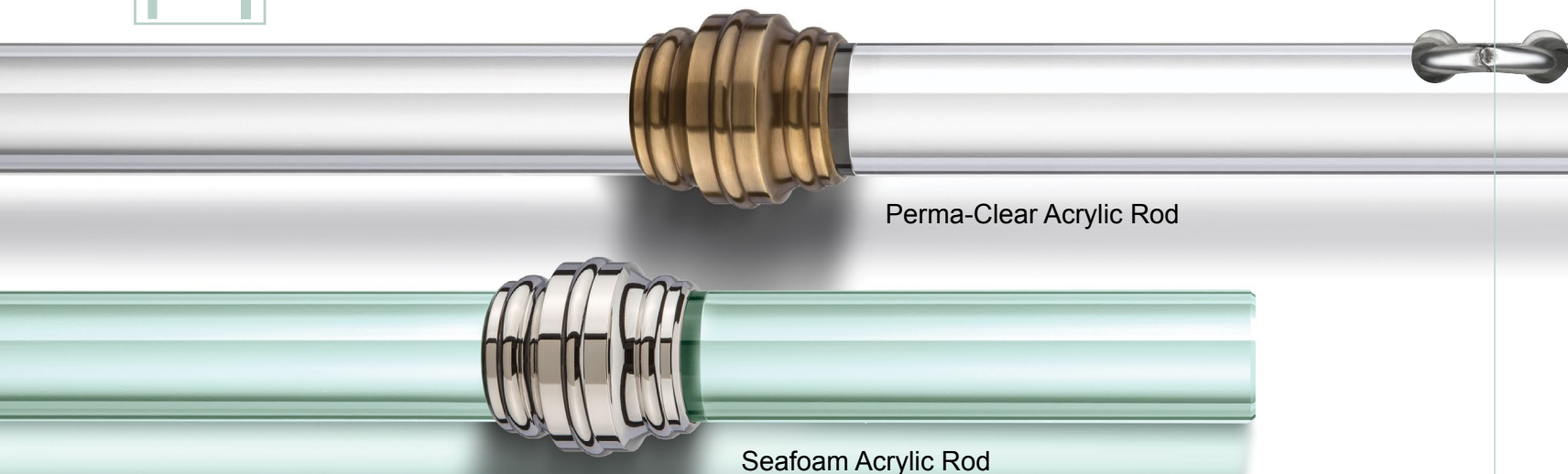

Perma-Clear Acrylic Rod

Seafoam Acrylic Rod

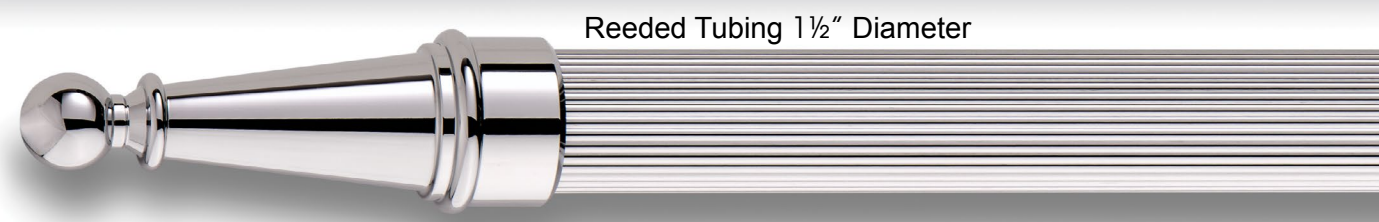

Reeded Tubing 1 1/2" Diameter

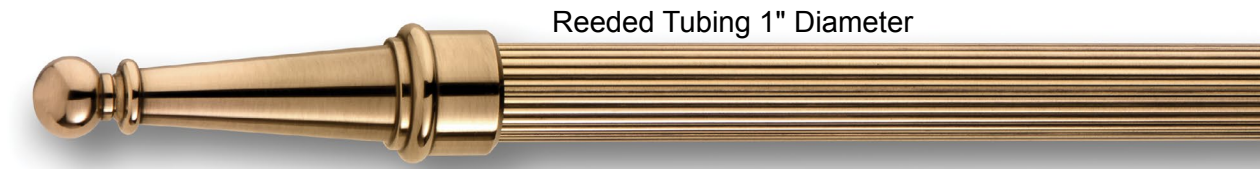

Reeded Tubing 1" Diameter

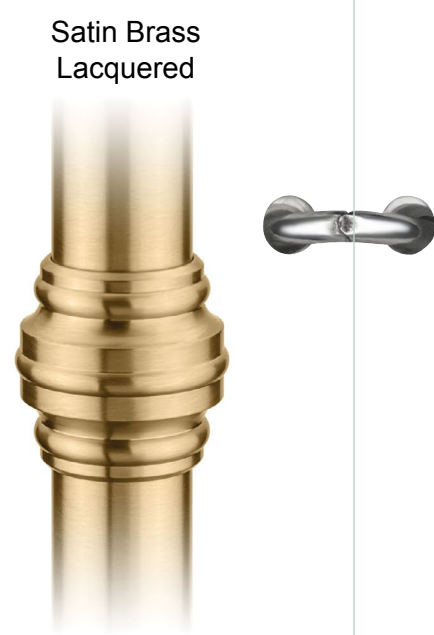

Satin Brass Lacquered

# The Polished Look of Palmer Perfection

The Palmer Palette includes a rich range of luxurious and durable platings, PVD coatings, and hand-rubbed "living finish" patinas. With the addition of clear and colored acrylic rods, reeded tubing, and our many functional accessories, your design choices are virtually unlimited...

\* contact Palmer for pricing and delivery of Premium PVD and Custom finishes

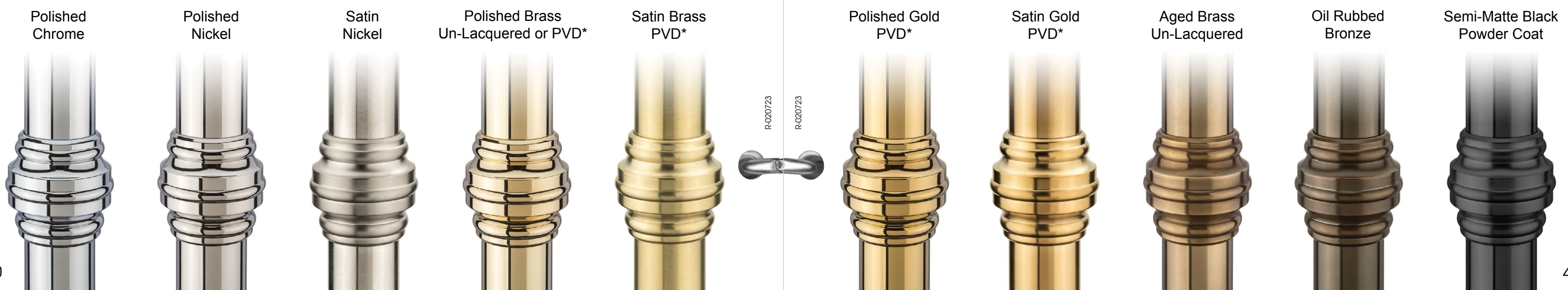

Polished Chrome

Polished Nickel

Satin Nickel

Polished Brass Un-Lacquered or PVD\*

Satin Brass PVD\*

Polished Gold PVD\*

Satin Gold PVD\*

Aged Brass Un-Lacquered

Oil Rubbed Bronze

Semi-Matte Black Powder Coat

## STYLES

### Classic Collection

- T** Tapered Foot 12
- C** Decorative Collar 13
- BL** Ball Foot 14
- B** Bun Foot 15

### Traditional Collection

- E** Essex 16
- W** Westport 17
- CAP** Capital 18
- K** Kingston 19
- V** Victorian 20
- P** Providence 21
- REN** Renaissance 22
- PREN** Petite Renaissance 23
- N** Newport 24
- BAY** Bayonne 25
- FR** Franklin 25
- EM** Embry 26
- SH** Soho 27

### Modern Collection

- S** Studio 28
- M** Minimal 29
- MET** Metro 30
- MOD** Modern 31
- SQ** Square 32
- L** Linear 33
- J** Jamestown 34
- BR** Bristol 35

### Wall Mount Collection

- REG** Regency 36
- A** Apex 37
- SG** Signature 38

- Finishes & Materials 40
- Shelving & Supports 42
- Options & Accessories 44
- Pairing with China Sinks 47
- Anatomy of a Leg System 48
- Tubing Diameter Reference 49
- Contact Palmer 50



click on a page number to navigate

The Palmer Story	4
Custom Sizing	6
Custom Designs	7
Precision Engineering	8

STYLES

<b>Classic Collection</b>	
<b>T</b> Tapered Foot	12
<b>C</b> Decorative Collar	13
<b>BL</b> Ball Foot	14
<b>B</b> Bun Foot	15
<b>Traditional Collection</b>	
<b>E</b> Essex	16
<b>W</b> Westport	17
<b>CAP</b> Capital	18
<b>K</b> Kingston	19
<b>V</b> Victorian	20
<b>P</b> Providence	21
<b>REN</b> Renaissance	22
<b>PREN</b> Petite Renaissance	23
<b>N</b> Newport	24
<b>BAY</b> Bayonne	25
<b>FR</b> Franklin	25
<b>EM</b> Embry	26
<b>SH</b> Soho	27
<b>Modern Collection</b>	
<b>S</b> Studio	28
<b>M</b> Minimal	29
<b>MET</b> Metro	30
<b>MOD</b> Modern	31
<b>SQ</b> Square	32
<b>L</b> Linear	33
<b>J</b> Jamestown	34
<b>BR</b> Bristol	35

<b>Wall Mount Collection</b>	
<b>REG</b> Regency	36
<b>A</b> Apex	37
<b>SG</b> Signature	38

Finishes & Materials	40
Shelving & Supports	42
Options & Accessories	44
Pairing with China Sinks	47
Anatomy of a Leg System	48
Tubing Diameter Reference	49
Contact Palmer	50

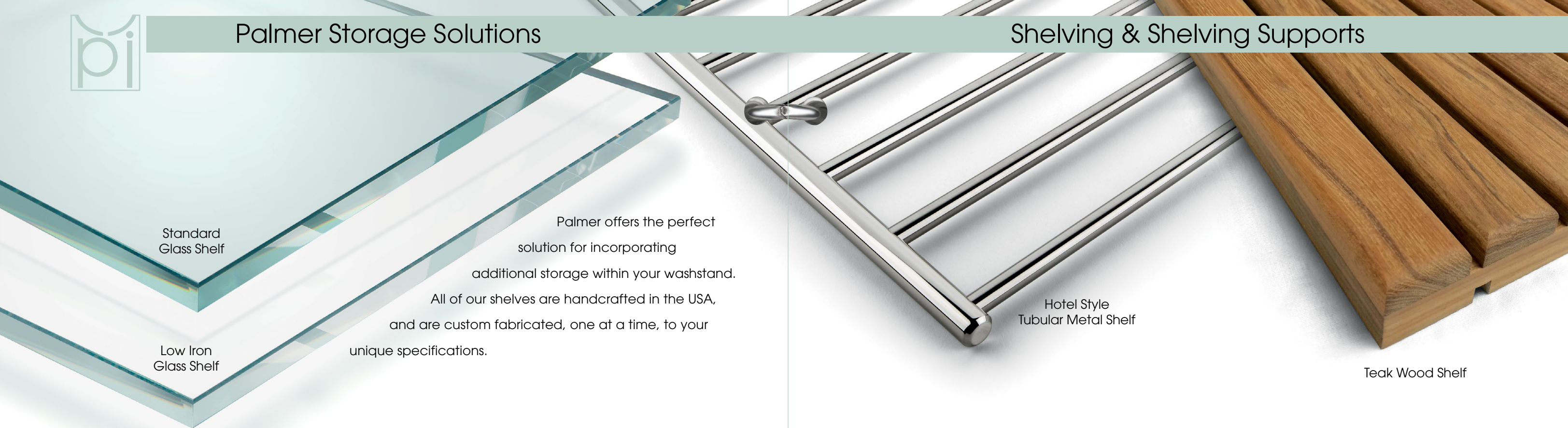

Standard Glass Shelf

Low Iron Glass Shelf

Palmer offers the perfect solution for incorporating additional storage within your washstand. All of our shelves are handcrafted in the USA, and are custom fabricated, one at a time, to your unique specifications.



Hotel Style Tubular Metal Shelf

Teak Wood Shelf

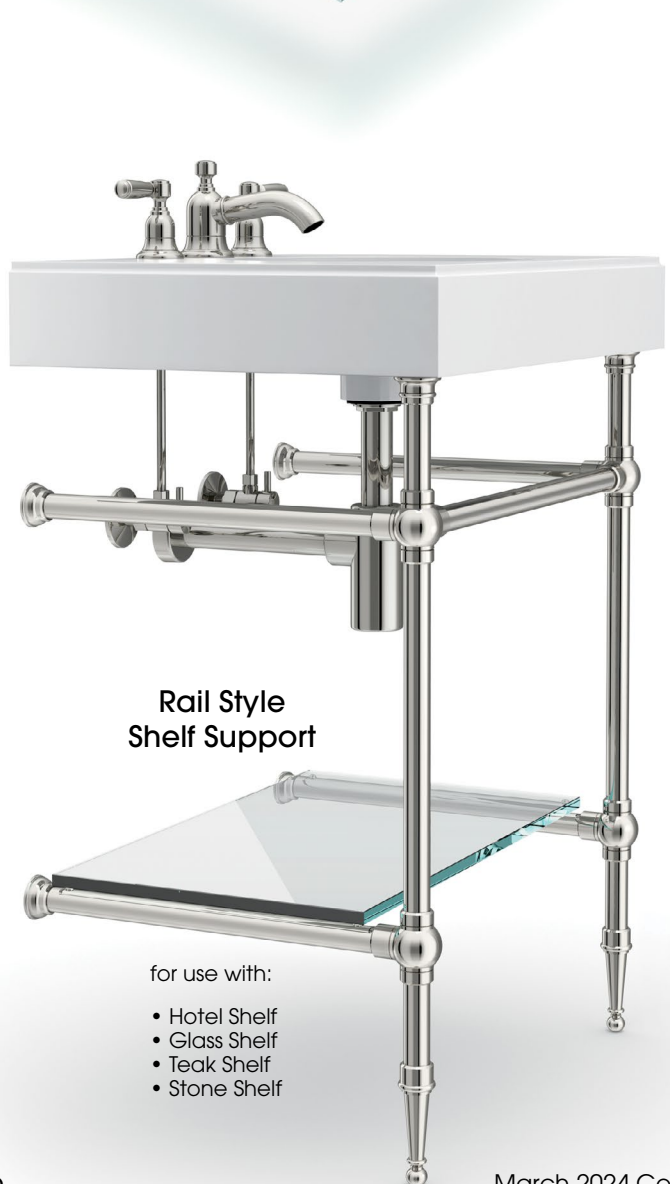

Rail Style Shelf Support

- for use with:
- Hotel Shelf
  - Glass Shelf
  - Teak Shelf
  - Stone Shelf



Low Profile Shelf Support

- for use with:
- Hotel Shelf
  - Glass Shelf
  - Teak Shelf
  - Stone Shelf

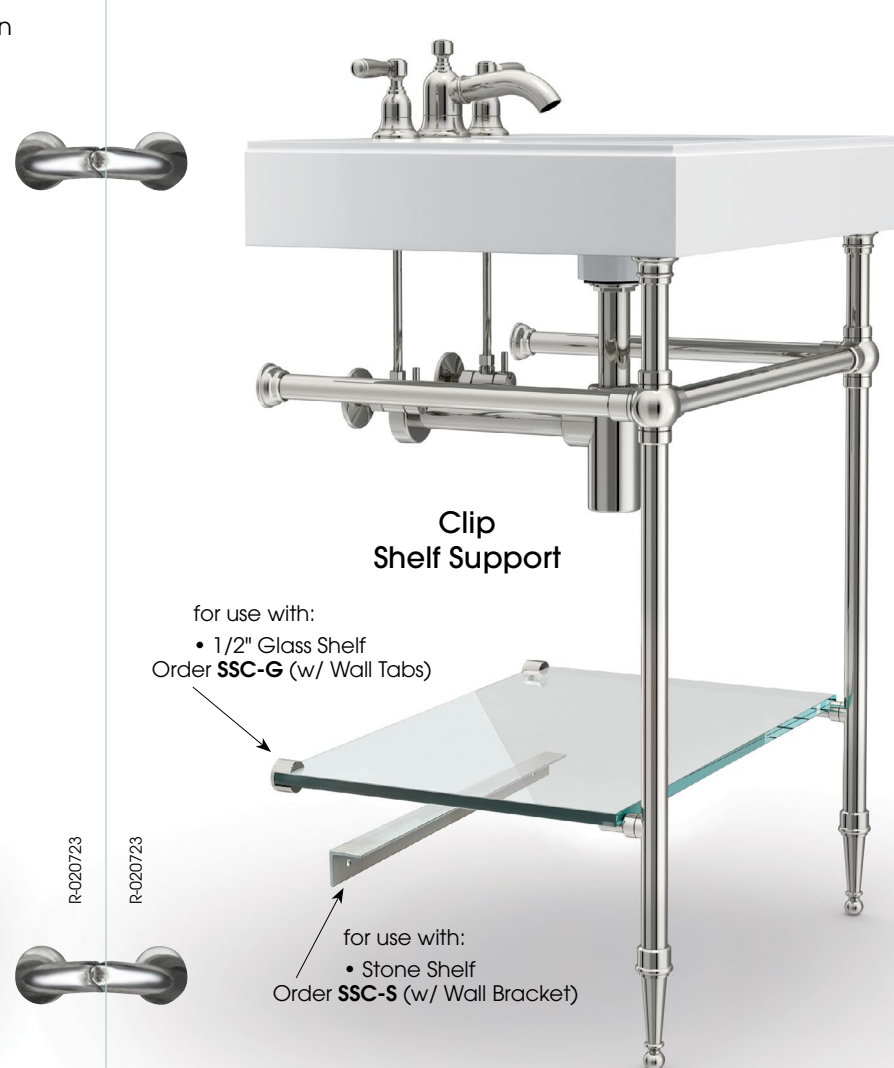

Clip Shelf Support

- for use with:
- 1/2" Glass Shelf
- Order **SSC-G** (w/ Wall Tabs)

- for use with:
- Stone Shelf
- Order **SSC-S** (w/ Wall Bracket)



Split Collar Shelf Support

- for use with:
- Stone Shelf

stone shelf provided by others

Palmer Industries has engineered four unique

shelf support systems to meet your shelving needs.



click on a page number to navigate

The Palmer Story	4
Custom Sizing	6
Custom Designs	7
Precision Engineering	8

STYLES

**Classic Collection**

<b>T</b> Tapered Foot	12
<b>C</b> Decorative Collar	13
<b>BL</b> Ball Foot	14
<b>B</b> Bun Foot	15

**Traditional Collection**

<b>E</b> Essex	16
<b>W</b> Westport	17
<b>CAP</b> Capital	18
<b>K</b> Kingston	19
<b>V</b> Victorian	20
<b>P</b> Providence	21
<b>REN</b> Renaissance	22
<b>PREN</b> Petite Renaissance	23
<b>N</b> Newport	24
<b>BAY</b> Bayonne	25
<b>FR</b> Franklin	25
<b>EM</b> Embry	26
<b>SH</b> Soho	27

**Modern Collection**

<b>S</b> Studio	28
<b>M</b> Minimal	29
<b>MET</b> Metro	30
<b>MOD</b> Modern	31
<b>SQ</b> Square	32
<b>L</b> Linear	33
<b>J</b> Jamestown	34
<b>BR</b> Bristol	35

**Wall Mount Collection**

<b>REG</b> Regency	36
<b>A</b> Apex	37
<b>SG</b> Signature	38

Finishes & Materials	40
Shelving & Supports	42
Options & Accessories	44
Pairing with China Sinks	47
Anatomy of a Leg System	48
Tubing Diameter Reference	49
Contact Palmer	50

Solid Acrylic Rod

Solid Brass Wall Bracket finished to match legs

Palmer Custom Mirror Supports

Front Riser

Curved Crossbar

Toilet Paper Holder

Hammered Ball Fitting

Auxiliary Towel Rail

1½" Diameter

Split Diameter Tubing

1" Diameter

R-020723

R-020723



click on a page number to navigate

The Palmer Story	4
Custom Sizing	6
Custom Designs	7
Precision Engineering	8

## STYLES

<b>Classic Collection</b>	
<b>T</b> Tapered Foot	12
<b>C</b> Decorative Collar	13
<b>BL</b> Ball Foot	14
<b>B</b> Bun Foot	15
<b>Traditional Collection</b>	
<b>E</b> Essex	16
<b>W</b> Westport	17
<b>CAP</b> Capital	18
<b>K</b> Kingston	19
<b>V</b> Victorian	20
<b>P</b> Providence	21
<b>REN</b> Renaissance	22
<b>PREN</b> Petite Renaissance	23
<b>N</b> Newport	24
<b>BAY</b> Bayonne	25
<b>FR</b> Franklin	25
<b>EM</b> Embry	26
<b>SH</b> Soho	27
<b>Modern Collection</b>	
<b>S</b> Studio	28
<b>M</b> Minimal	29
<b>MET</b> Metro	30
<b>MOD</b> Modern	31
<b>SQ</b> Square	32
<b>L</b> Linear	33
<b>J</b> Jamestown	34
<b>BR</b> Bristol	35
<b>Wall Mount Collection</b>	
<b>REG</b> Regency	36
<b>A</b> Apex	37
<b>SG</b> Signature	38

Finishes & Materials	40
Shelving & Supports	42
Options & Accessories	44
Pairing with China Sinks	47
Anatomy of a Leg System	48
Tubing Diameter Reference	49
Contact Palmer	50

## THE PLATED FINISHES...

LUXURIOUS LUSTER  
OR SATIN SHEEN

Our chrome and nickel plated finishes are architectural grade, consistent with the quality of premium decorative plumbing fixtures. These plated finishes are not lacquered and the nickel finishes may require occasional cleaning.



Polished Chrome (PC)



Polished Nickel (PN)



Satin Nickel (SN)



Powder Coat Semi-Matte Black (MB)



Palmer washstands are the natural choice for supporting china or porcelain sinks...the perfect marriage.

Palmer leg systems can be sized to accommodate almost any choice of china sink.

Sizing a stand to properly fit a china sink can be accomplished three ways:

1. Choose a china sink from our online database located on our website Resources page at [sinklegs.com/sinks](http://sinklegs.com/sinks). This database represents a current listing of sinks that Palmer has evaluated. Palmer will build the stand to fit the sink exactly.
2. Drop-ship the sink directly to Palmer for proper sizing evaluation. Palmer will then take all the appropriate measurements, and determine a washstand size that fits the sink perfectly. Please contact palmer for shipping arrangements.
3. Order the washstand larger than required with the intention of cutting the leg system on-site to fit the sink. Note: shelves cannot be field cut.

## THE LIVING FINISHES...

AGING WITH BEAUTY, GRACE,  
AND A RICH PATINA

The living finishes offer an ever-changing patina, as their tone and luster will gracefully age with time and unique environmental conditions. These hand-crafted artisanal finishes are subject to variations in lightness and color tone.



Satin Brass Lacquered (SBL)



Polished Brass Un-Lacquered (PBUL)



Aged Brass Un-Lacquered (ABUL)



Oil Rubbed Bronze (ORB)



## THE PVD FINISHES...

DURABLE, COLORFUL,  
AND TARNISH-FREE  
FINISHING TECHNOLOGY

Our premium PVD finishes (Physical Vapor Deposition) incorporate a coating of specialized metal that provides a durable, tarnish-free, and lasting color tone.

\* Contact Palmer for pricing & delivery of PVD finishes



Polished Brass PVD\* (PBPVD)



Satin Brass PVD\* (SBPVD)



Polished Gold PVD\* (PGPVD)



Satin Gold PVD\* (SGPVD)

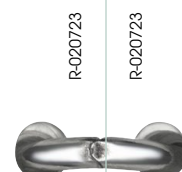

Minimal with Duravit DuraStyle sink





The Palmer Story	4
Custom Sizing	6
Custom Designs	7
Precision Engineering	8

### STYLES

<b>Classic Collection</b>	
<b>T</b> Tapered Foot	12
<b>C</b> Decorative Collar	13
<b>BL</b> Ball Foot	14
<b>B</b> Bun Foot	15
<b>Traditional Collection</b>	
<b>E</b> Essex	16
<b>W</b> Westport	17
<b>CAP</b> Capital	18
<b>K</b> Kingston	19
<b>V</b> Victorian	20
<b>P</b> Providence	21
<b>REN</b> Renaissance	22
<b>PREN</b> Petite Renaissance	23
<b>N</b> Newport	24
<b>BAY</b> Bayonne	25
<b>FR</b> Franklin	25
<b>EM</b> Embry	26
<b>SH</b> Soho	27
<b>Modern Collection</b>	
<b>S</b> Studio	28
<b>M</b> Minimal	29
<b>MET</b> Metro	30
<b>MOD</b> Modern	31
<b>SQ</b> Square	32
<b>L</b> Linear	33
<b>J</b> Jamestown	34
<b>BR</b> Bristol	35
<b>Wall Mount Collection</b>	
<b>REG</b> Regency	36
<b>A</b> Apex	37
<b>SG</b> Signature	38

Finishes & Materials	40
Shelving & Supports	42
Options & Accessories	44
Pairing with China Sinks	47
Anatomy of a Leg System	48
Tubing Diameter Reference	49
Contact Palmer	50

Counters MUST be securely fastened to the wall, independent of the leg system, with the Palmer Wall Bracket or equivalent. This is critically important to the structural integrity of the leg system.

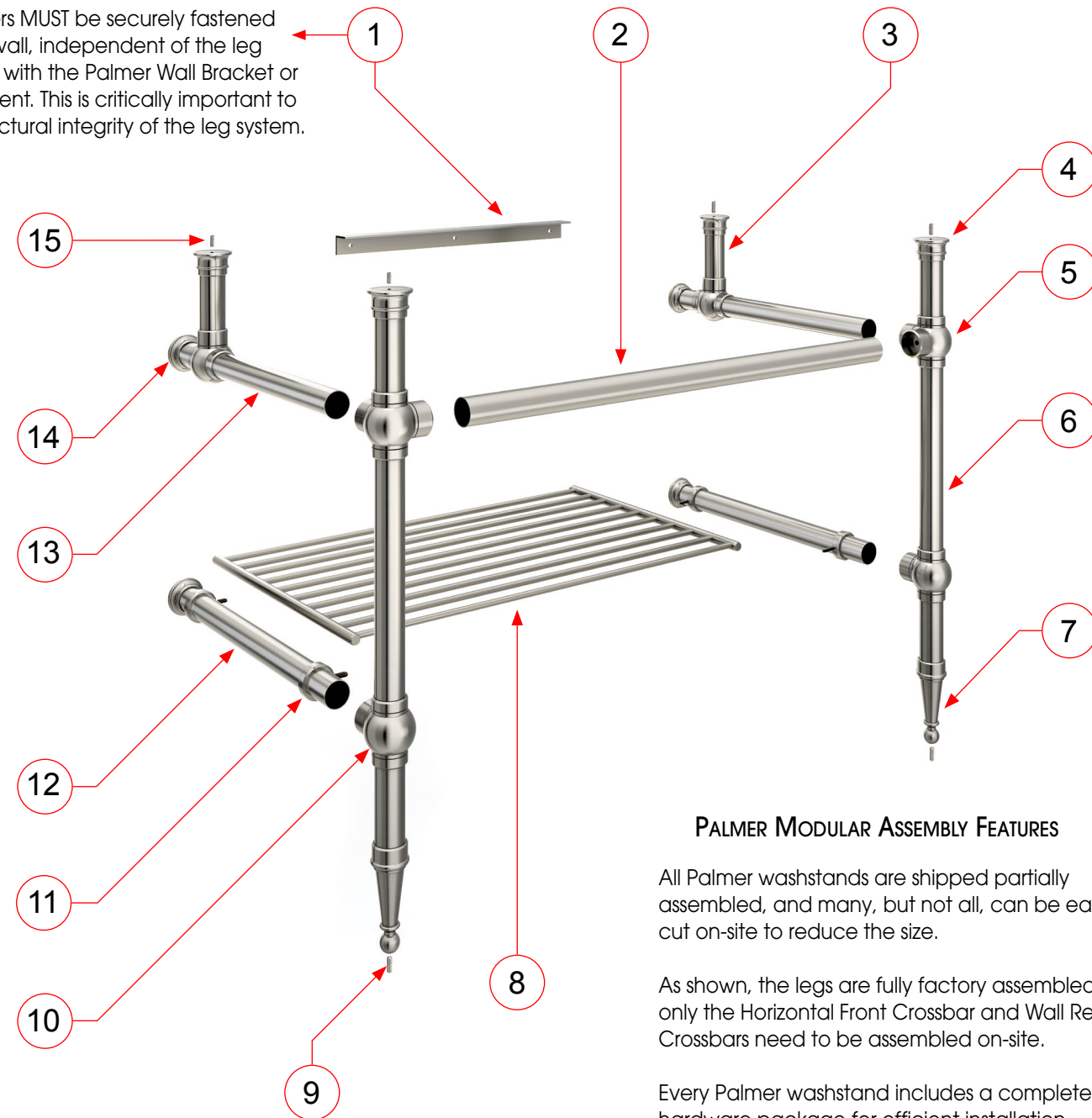

#### PALMER MODULAR ASSEMBLY FEATURES

All Palmer washstands are shipped partially assembled, and many, but not all, can be easily cut on-site to reduce the size.

As shown, the legs are fully factory assembled, so only the Horizontal Front Crossbar and Wall Return Crossbars need to be assembled on-site.

Every Palmer washstand includes a complete hardware package for efficient installation.

- 1. Wall Bracket
- 2. Front Crossbar
- 3. Rear Riser (optional)
- 4. Top Cap
- 5. Corner Joint
- 6. Leg Tube
- 7. Foot
- 8. Shelf (optional)
- 9. Floor Pin
- 10. Shelf Support Tee Joint (optional)
- 11. Shelf Support Ring (optional)
- 12. Shelf Support Tube (optional)
- 13. Wall Return Crossbar
- 14. Wall Flange
- 15. Counter Pin

## ACTUAL SIZE TUBING DIAMETERS

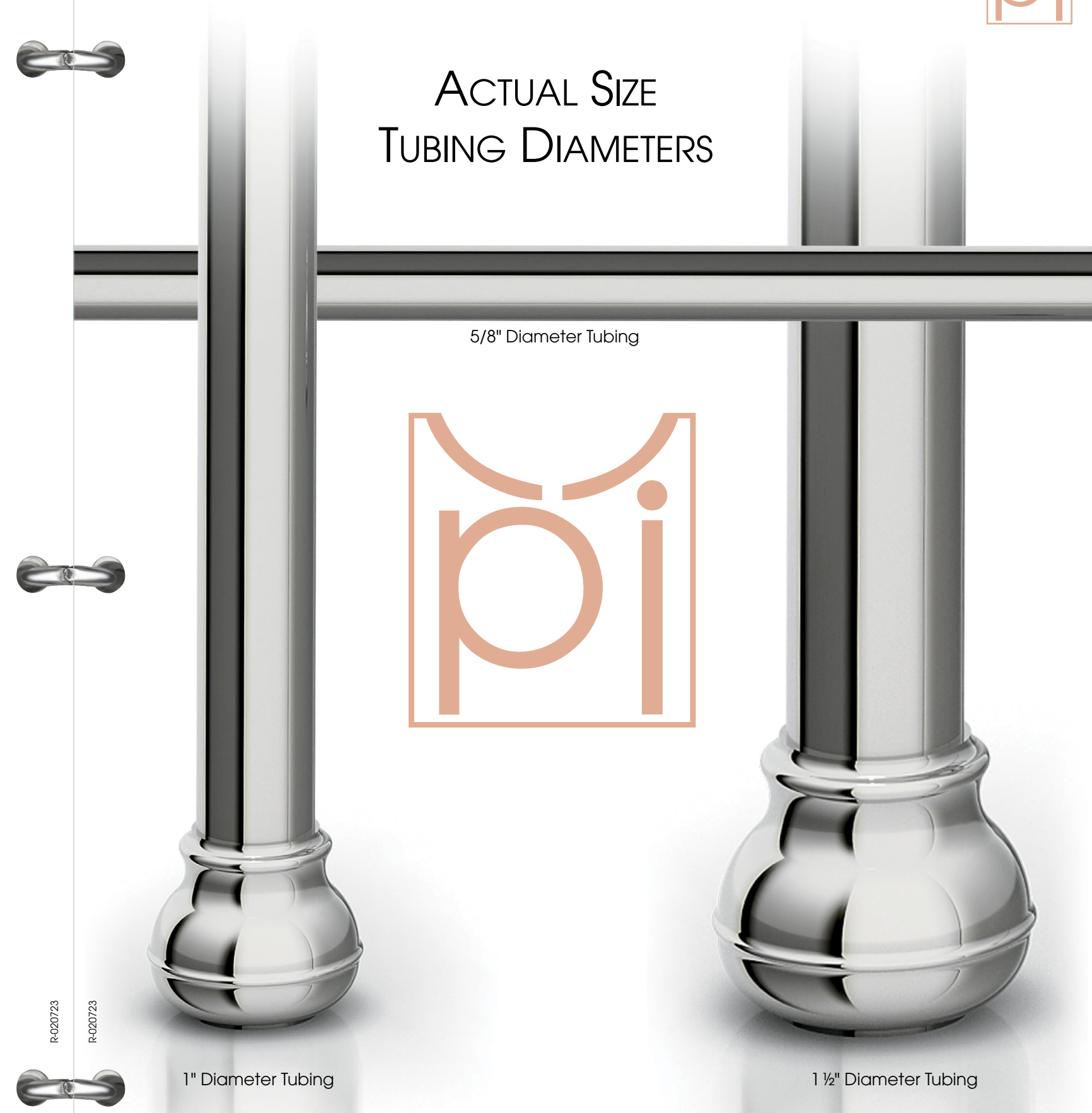

5/8" Diameter Tubing

1" Diameter Tubing

1 1/2" Diameter Tubing

# PALMER INDUSTRIES

CUSTOM SINK LEG SOLUTIONS



Palmer Industries

[info@palmerindustries.com](mailto:info@palmerindustries.com)

[palmerindustries.com](http://palmerindustries.com)

[sinklegs.com](http://sinklegs.com)

phone: (401) 421-1730

American Manufacturing



Warwick, Rhode Island

© 2024 Palmer Industries all rights reserved